

MFTM0802/2WD-PG

Inductive Proximity Sensor

(Metal Face Teflon Coated Anti Welding Spatter)

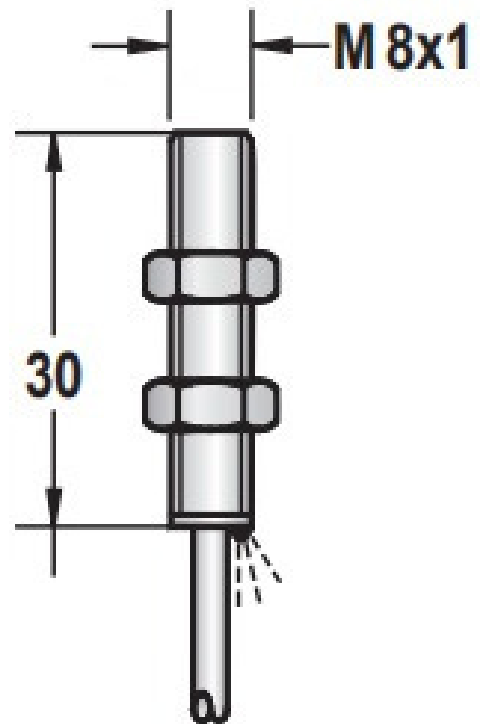

Installation type	Flush
Detection distance	2mm
Voltage	10-30VDC
Output polarity	Two wire NO
Connection mode	Pigtail 300mm M8-3Pin (Male Connector)
Shell material	Stainless steel teflon coated
Other notes	Short type

Technical data

Installing	Flush
Sensing distance	2mm
LED display	Yes
Operation voltage	10-30VDC
Ripple	<10%
No load current	<10mA
Max load current	200mA
Leakage current	<0.01mA
Voltage drop	<1.5v
Frequency	1KHZ
Response time	0.1ms
Hysteresis	<15%sr
Repeat accuracy	<1.0%sr
Protection category	IP67
Operating temperature	-25°C----+70°C
Temperature drift	<10%sr
Short circuit protection/reverse polarity protection	Yes
Overload trip point	220mA
Material active face	Stainless steel teflon coated
Connecting way	Pigtail 300mm M8-3Pin (Male Connector)

Connecting Diagram (Two wire NO)

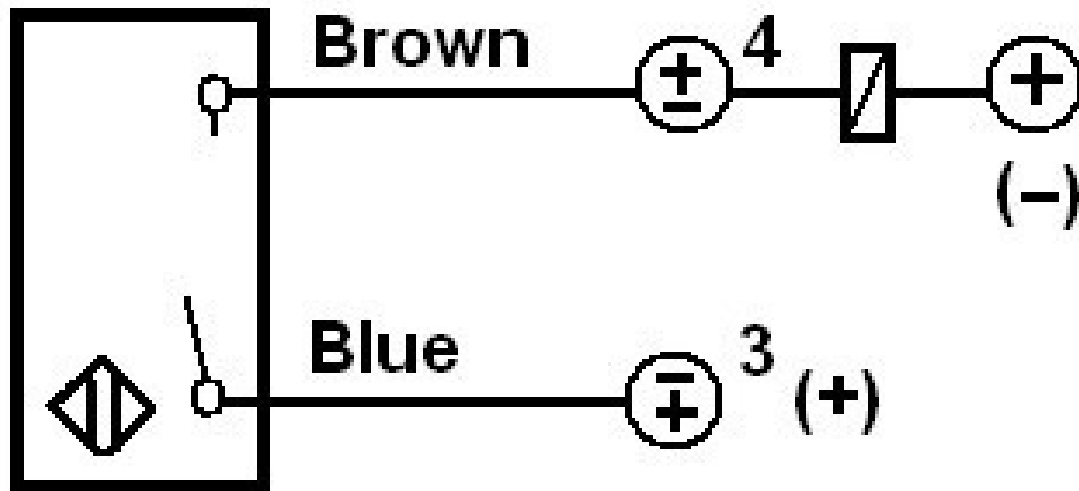

1. Please connect the proximity switch as per wiring diagram

VoxinTech

Email: info@voxintech.com

Website: www.voxintech.com